

BRIGHT®



THE DAVIDS MODULAR SOFA

© DESIGNED BY DOUGLAS LEVINE

BRIGHT CHAIR COMPANY 51 RAILROAD AVENUE, MIDDLETOWN, NEW YORK 10940 TEL 1.888.524.5997 FAX 845.343.4958 WWW.BRIGHTCHAIR.COM

THE BRIGHT GROUP®

THEBRIGHTGROUP.COM

BOSTON  
617.345.8017

CHICAGO  
312.527.05570

DALLAS  
214.760.8440

NEW YORK  
212.726.9030

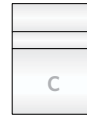

**4100**  
**SQUARE**

W: 25 D: 25 H: 28.5  
SEAT HEIGHT: 17  
COM: 6 YDS  
COL: 119 SQ FT  
PILLOW: 1.5 YDS/30 SQ FT

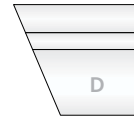

**4116**  
**RIGHT END**

W: 39 D: 34.5 H: 28.5  
SEAT HEIGHT: 17  
COM: 6 YDS  
COL: 119 SQ FT  
PILLOW: 1.5 YDS/30 SQ FT



**4115**  
**CORNER**

W: 44 D: 34.5 H: 28.5  
SEAT HEIGHT: 17  
COM: 6 YDS  
COL: 119 SQ FT  
PILLOW: 1.5 YDS/30 SQ FT

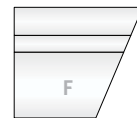

**4118**  
**LEFT END**

W: 39 D: 34.5 H: 28.5  
SEAT HEIGHT: 17  
COM: 6 YDS  
COL: 119 SQ FT  
PILLOW: 1.5 YDS/30 SQ FT

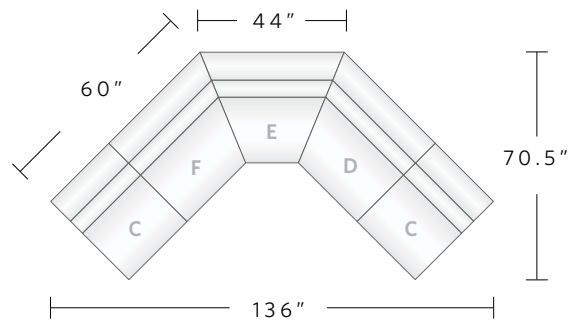

BRIGHT®



THE DAVIDS MODULAR SOFA

© DESIGNED BY DOUGLAS LEVINE

BRIGHT CHAIR COMPANY 51 RAILROAD AVENUE, MIDDLETOWN, NEW YORK 10940 TEL 1.888.524.5997 FAX 845.343.4958 WWW.BRIGHTCHAIR.COM



4105  
SMALL FRONT  
LARGE BACK

W: 25 D: 35.5 H: 28.5  
SEAT HEIGHT: 17  
COM: 6 YDS  
COL: 119 SQ FT  
PILLOW: 1.5 YDS/30 SQ FT

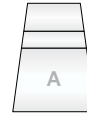

4110  
LARGE FRONT  
SMALL BACK

W: 25 D: 35.5 H: 28.5  
SEAT HEIGHT: 17  
COM: 6 YDS  
COL: 119 SQ FT  
PILLOW: 1.5 YDS/30 SQ FT

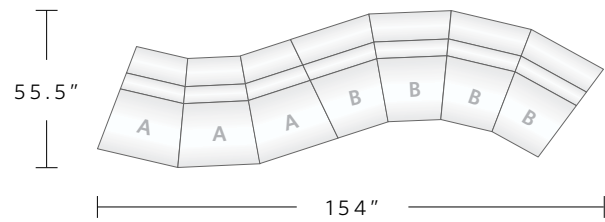
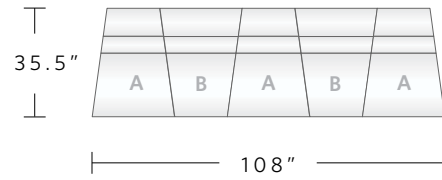

BRIGHT®



THE DAVIDS LOUNGE CHAIR & OTTOMAN

© DESIGNED BY DOUGLAS LEVINE

BRIGHT CHAIR COMPANY 51 RAILROAD AVENUE, MIDDLETOWN, NEW YORK 10940 TEL 1.888.524.5997 FAX 845.343.4958 WWW.BRIGHTCHAIR.COM

# THE DAVIDS - MODULAR ELEMENTS

STRAIGHT

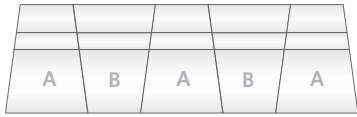

CORNER

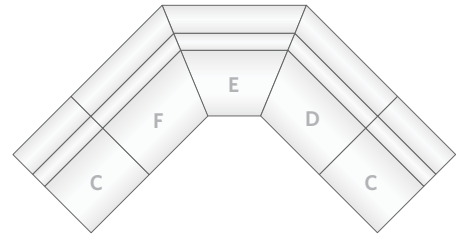

SNAKE

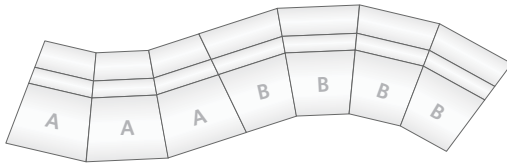

L SHAPE

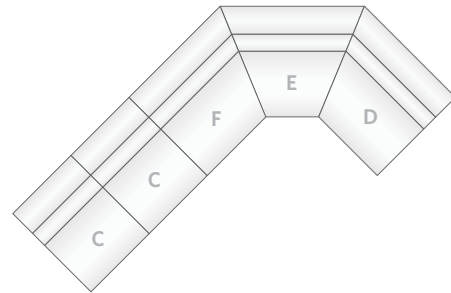

CURVE

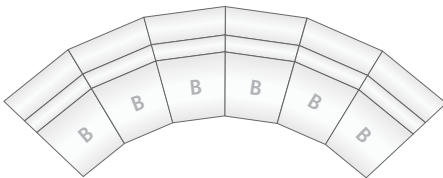

HALF RACETRACK

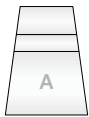
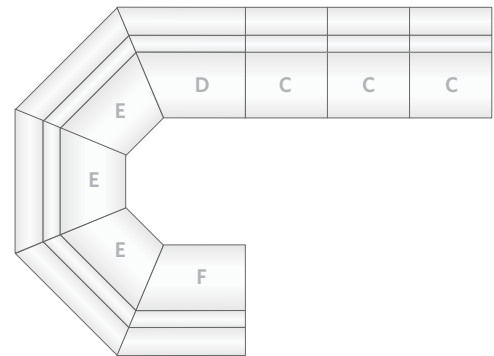

4110  
LARGE FRONT  
SMALL BACK

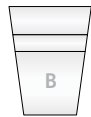

4105  
SMALL FRONT  
LARGE BACK

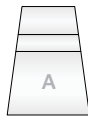

4120  
OTTOMAN



4122  
OTTOMAN



4124  
OTTOMAN

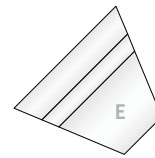

4115  
CORNER

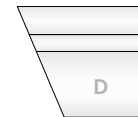

4116  
RIGHT END

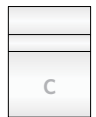

4100  
SQUARE

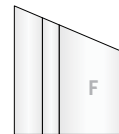

4118  
LEFT END



4100  
SQUARE